

A Multi-Function Digital Service Instrument.
A New Concept in Data Representation:
The Complete Integration of Graphics and
Alphanumerics.

The Virtual Bit Map Brings High Resolution Graphics
to the Alphanumeric Terminal User.
Evaluating Test Data with Computer Graphics.

Volume 10
Number 1
1978

Tekscope



Tektronix
COMMITTED TO EXCELLENCE

Contents

Tekscope

Customer information from
Tektronix, Inc.
Beaverton, Oregon 97007

Editor: Gordon Allison

A Multi-Function Digital Service Instrument

The 851 Digital Tester, a new concept in service instruments, combines the functions of several different test instruments in one small, portable, easy-to-use package.

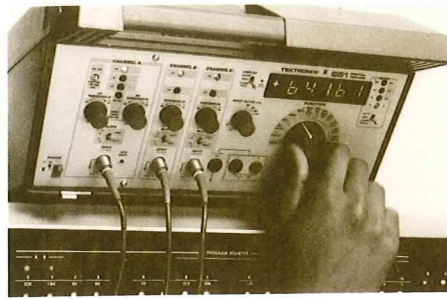

Tekscope is a bimonthly publication of Tektronix, Inc. In it you will find articles covering the entire scope of Tektronix' products. Technical articles discuss what's new in circuit and component design, measurement capability, and measurement technique. A new products section gives a brief description of products recently introduced and provides an opportunity to request further information.

To better serve customers who maintain their TEKTRONIX instruments, the service information formerly appearing in Tekscope will be expanded and published in a publication dedicated to the service function.

A New Concept in Data Representation: The Complete Integration of Graphics and Alphanumeric

The 4025 Computer Display Terminal brings versatile, easy-to-use graphics to the alphanumeric terminal user. From a basic alphanumeric terminal, the 4025 can be expanded to include forms ruling and extensive graphics capability.

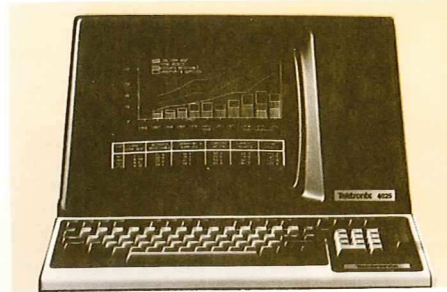

The Virtual Bit Map Brings High Resolution Graphics to the Alphanumeric Terminal User

An interesting variation in the traditional method of storing graphics data makes it possible to scroll graphics and alphanumeric together, and reduces the memory required for graphics.

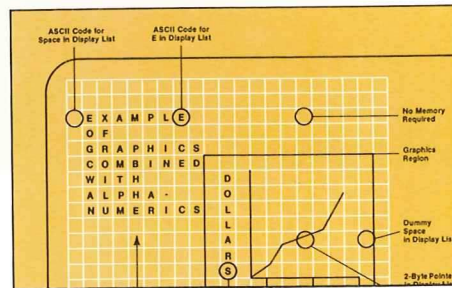

Evaluating Test Data with Computer Graphics

Use of a graphic computer terminal for data previewing saves time and expense in solid-propellant rocket fuel research at Georgia Tech.

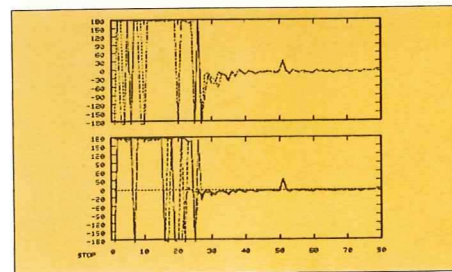

Cover

The simple, uncluttered front panel of the 851 Digital Tester belies the wide-ranging measurement capability contained in this small, portable package.

A Multi-Function Digital Service Instrument. The Virtual Bit Map Brings High Resolution Graphics to the Alphanumeric Terminal User. A New Concept in Data Representation: The Complete Integration of Graphics and Alphanumeric. Evaluating Test Data with Computer Graphics.

Volume 6
Number 1
1978

Tekscope

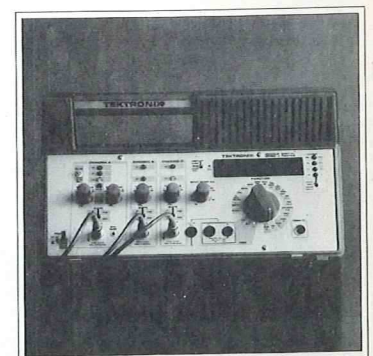

Tektronix
CORPORATION

Copyright © 1978, Tektronix, Inc. All rights reserved. Printed in U.S.A. Foreign and U.S.A. Products of Tektronix, Inc. are covered by U.S.A. and Foreign Patents and/or Patents Pending. Information in this publication supersedes all previously published material. Specification and price change privileges reserved. TEKTRONIX, TEK, SCOPE-MOBILE, TELEQUIPMENT, and  are registered trademarks of Tektronix, Inc., P. O. Box 500, Beaverton, Oregon 97077, Phone: (Area Code 503) 644-0161, TWX: 910-467-8708, Cable: TEKTRONIX. More than 50 Subsidiaries/Distributors around the world.

A Multi-Function Digital Service Instrument



Dave Allen started his career with Tek in 1968 after completing his B.S.E.E. at Brigham Young University. He has been project leader for all of the 200-Series hand-held miniscopes which include single and dual trace instruments, bandwidths from 500 kHz to 5 MHz, bistable storage, and one which contains both a DMM and miniscope in one unit. All operate from internal batteries. Dave was project manager for the 851 Digital Tester program.

The digital products population is exploding. And how to effectively service these products is of prime concern to both suppliers and users.

A substantial share of service activity in digital systems is devoted to maintaining and adjusting electromechanical devices as well as troubleshooting computer peripherals, point-of-sale terminals, microprocessor systems, and other subsystems. This calls for the use of several types of instruments — oscilloscopes, counters, digital multimeters, logic probes, and usually some specialized instruments.

The TEKTRONIX 851 Digital Tester, a new concept in service instruments, was developed to meet such a need — increasing the customer service engineer's effectiveness and efficiency in performing routine preventative maintenance, non-routine alignment and adjustment, and troubleshooting.

The major design goal was to incorporate the needed measurement capability in a lightweight portable package that would be easy to carry, easy to use, and highly reliable. Easy to use dictated that front panel controls be kept to a minimum, and that they be easy to understand and operate. It was decided that every measurement should be converted to an unambiguous numerical readout that would enable the operator to quickly determine normal or faulty operation right down to the component level.

Considerable effort was put into human engineering to tailor the 851 to the varied work environments encountered by the customer service engineer. The sloped-front-panel design was chosen to yield a large front-panel area providing an uncluttered appearance and easy access to controls. It makes the unit convenient to use whether it's sitting on the floor, the workbench, or atop a computer cabinet. A further advantage is that storage space can be provided for probes and accessories without adding to the overall dimensions of the unit.

There are very few controls on the front panel, the most prominent

being the FUNCTION switch. With this single control, twenty-two functions can be selected — eleven measure timing, two measure plus and minus peak voltages, three perform DMM measurements, and one reads line voltage supplied to the 851. Four positions measure threshold voltages on the three counter probes, and the final position measures temperature using an optional temperature probe. There are three sets of probes that are used with the 851 — three counter probes for channels A, B, and C, two DMM probes, and the optional temperature probe. Except for the DMM and temperature measurements, most measurements are made using Channel A. Channels B and C are used for some timing functions, and the gating of Channel A signals.

Operation is greatly simplified by the color coded FUNCTION switch, channel control areas, and probes. The colored bands on the FUNCTION switch correspond to the colored bands on the probe, or probes, to be used for a particular function. You will note that for some of the timing functions all three probes are used.

There is a minimum number of controls for each channel — just a SLOPE switch and THRESHOLD control. There are no attenuator, gain, or coupling controls to worry about. Since some measurements require sensing both HI and LO levels, Channel A is provided with two THRESHOLD controls. The two

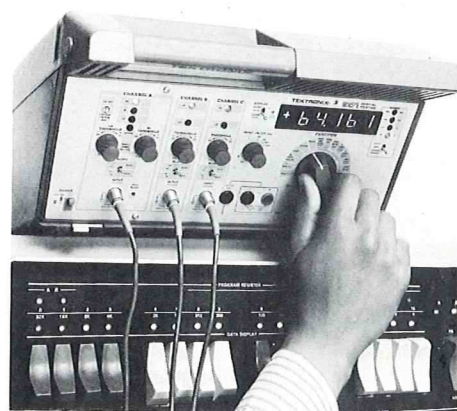

Fig. 1 The sloping front panel of the 851 provides good visibility and easy access to controls whether the unit is sitting on the floor, the workbench, or atop a computer cabinet as in this photo.

thresholds can be made to track by setting the LO threshold above the HI threshold. A front-panel light indicates when you are in this mode. The threshold levels may be set over a range of -30 to +30 volts with a resolution of 10 millivolts, by setting the FUNCTION switch to the appropriate position and reading the threshold voltage on the display. Each THRESHOLD control has a detent position present for TTL trigger levels.

Logic state indicators for each channel provide a logic probe capability for the 851. Channel A has three indicators — HI, LO, and X for signal activity in the in-between state. Channels B and C have only HI and LO indicators. Either of these two channels can serve as a logic probe while Channel A is being used for another measurement.

There is one other variable control on the front panel — the INPUT FILTER. Digital signals often contain noise generated by race conditions, ripple counters, etc. While these signals are not large enough to affect circuit operation, they could be sensed by the wideband amplifiers in the 851 and cause erroneous measurements. To prevent this, the input filter can be set to reject signals having a duration of less than 50 nanoseconds, up to as much as 300 nanoseconds. It can also be turned off to accept all signals above 14 nanoseconds. The filter operates on Channels A, B, and C.

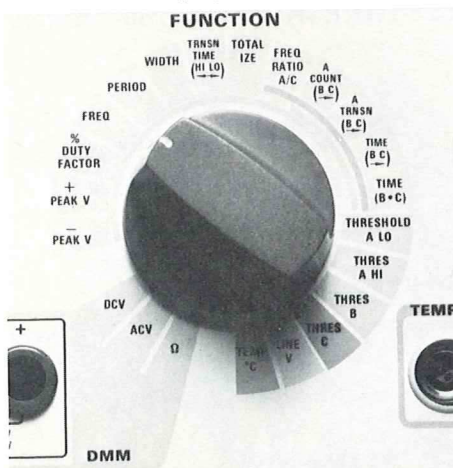

Fig. 2 The function switch allows the operator to select which one of twenty-two functions will be performed and arranges the internal circuitry to accomplish it.

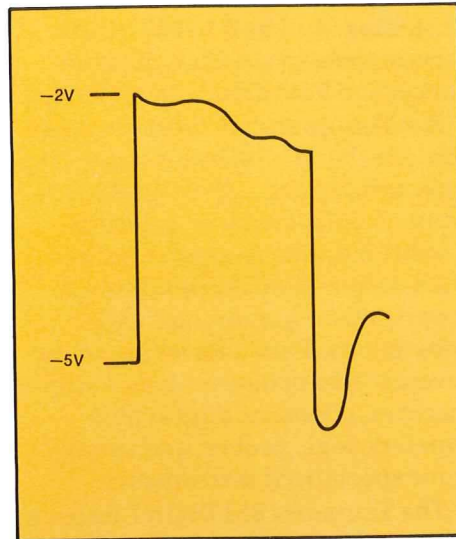

Fig. 3 The + PEAK function measures the most positive peak of the input signal. The display will show a negative number if the most positive peak happens to be a negative voltage as in this example.

In keeping with the goal of providing an unambiguous readout for all measurements, the 851 is completely autoranging. The FUNCTION switch is color coded to indicate the proper probes for the measurement and brings the necessary circuitry into play to convert the input signal to an appropriate display. The readout is a large, bright, five-digit LED display. Timing measurements use all five digits, while the DMM provides 4½ digits. The display is updated three times a second for most functions. For timing or gated functions, the display is held until a new measurement occurs; the display for any measurement may be saved indefinitely by putting the DISPLAY switch in SAVE. A CLEAR TEST position clears the display, resets the counters to zero, and gives a test reading of ±8.8.8.8 to verify proper operation of the readout. The autoranging function can be deactivated by placing the RANGE switch in the MNL mode. This is sometimes desirable to prevent the readout from changing ranges while making adjustments to equipment.

Self test an important feature.

The ability to quickly determine the operating condition of your test instrument can often save many

wasted hours of troubleshooting. The CAL OUT signal provides such a capability for the 851. When all of the probes (except temperature) are attached to this signal, you can step through all the functions and get a unique reading for each function that assures you the instrument is operating properly. The CAL OUT signal is dependent on the setting of the FUNCTION switch. In the + and - Peak V positions the output remains at +8 volts for two seconds, then alternates between +8 and -4 volts at a 5 kHz rate for eight seconds. This special feature is used to compensate channel A input for accurate measurements. For the other functions the output alternates at a 5 kHz rate continuously.

A look at the functions.

With this brief overview let's take a look at the functions performed by the 851. Specifications for the 851 are shown at the close of this article so they will not be discussed in detail as we consider the individual functions.

The digital multimeter functions: dc volts, ac volts, and resistance are performed by the DMM section of the 851. The DMM inputs are fully floating and rated at ±500 volts peak. Considerable effort was expended to ensure the 851 would maintain measurement accuracy and safety specifications over the wide range of humidity and temperature expected to be encountered by a service-type instrument. Components such as precision thin film attenuators for the front end, relays for the autoranging circuitry, and Teflon IC sockets, wires, and solder cups for making connection to the circuit board were all selected to ensure conformance to the rigid specifications.

Several functions use the dual slope analog-to-digital converter in the DMM to measure the signal but do not use the DMM input probes. These include plus and minus peak voltage, percent duty factor, threshold levels, line voltage, and temperature. The + and -Peak V functions provide a direct readout of

the most positive or negative peak of a repetitive signal applied to Channel A input. The positive peak does not have to be a positive voltage. For example, -3 volts may be the positive peak of a signal whose average level is -5 volts dc. The converse is true for negative peaks.

The measurement is accomplished by comparing the input signal to a dc voltage from the peak detector circuit, instead of to the voltage from the THRESHOLD control. If the input signal peak exceeds this dc level, the peak detector increases the dc voltage. Conversely, if the input peaks do not reach this dc level for a set period, the voltage is decreased. The resulting dc voltage is measured by the analog-to-digital converter portion of the DMM.

The Percent Duty Factor function averages the time the input signal is above or below the Channel A threshold setting and displays it as a percentage on the digital readout. The slope switch setting determines whether the measurement is the

percentage of the time the signal is HI or the percentage of the time it is LO. Duty factor from 0 to 100% can be measured at dc and over a range from 40 Hz to 10 Mhz.

Frequency measurements are also made using Channel A. Frequencies up to 35 MHz can be measured to an accuracy of $\pm 0.005\%$ of reading ± 1 count.

The next three functions — Period, Width, and Transition Time are timing measurements which involve the counting of an internal 100 MHz clock. These measurements are made using Channel A only and in much the same manner as using a counter. The slope switch setting determines whether the positive or negative pulse width, or the rise or fall time is measured. Minimum measurable pulse width and transition time is 20 nanoseconds.

The Totalize function is similar to that found on other counters and is performed using Channel A. The DISPLAY switch is used to start and stop the count. The CLEAR TEST

position of this switch serves as a reset, and as a test function for the display. The readout is updated 100 times a second for this function.

The functions we have discussed thus far require only the use of Channel A. The next five functions use two, and sometimes all three, channels to make the measurement.

Frequency Ratio A/C uses Channel A and C inputs. This measurement, basically, counts the number of events on Channel A that occur during the period of one event on Channel C. A typical application for this function is checking a divide-by-N counter. The measurement can be made even when a random clock is used.

The A Count (B→C) and A Transitions (B→C) functions use all three inputs, with Channels B and C used to gate the measurement of a signal on Channel A. The threshold and slope settings on Channel B define the start of the gate while those on Channel C define the termination.

The two measurements are simi-

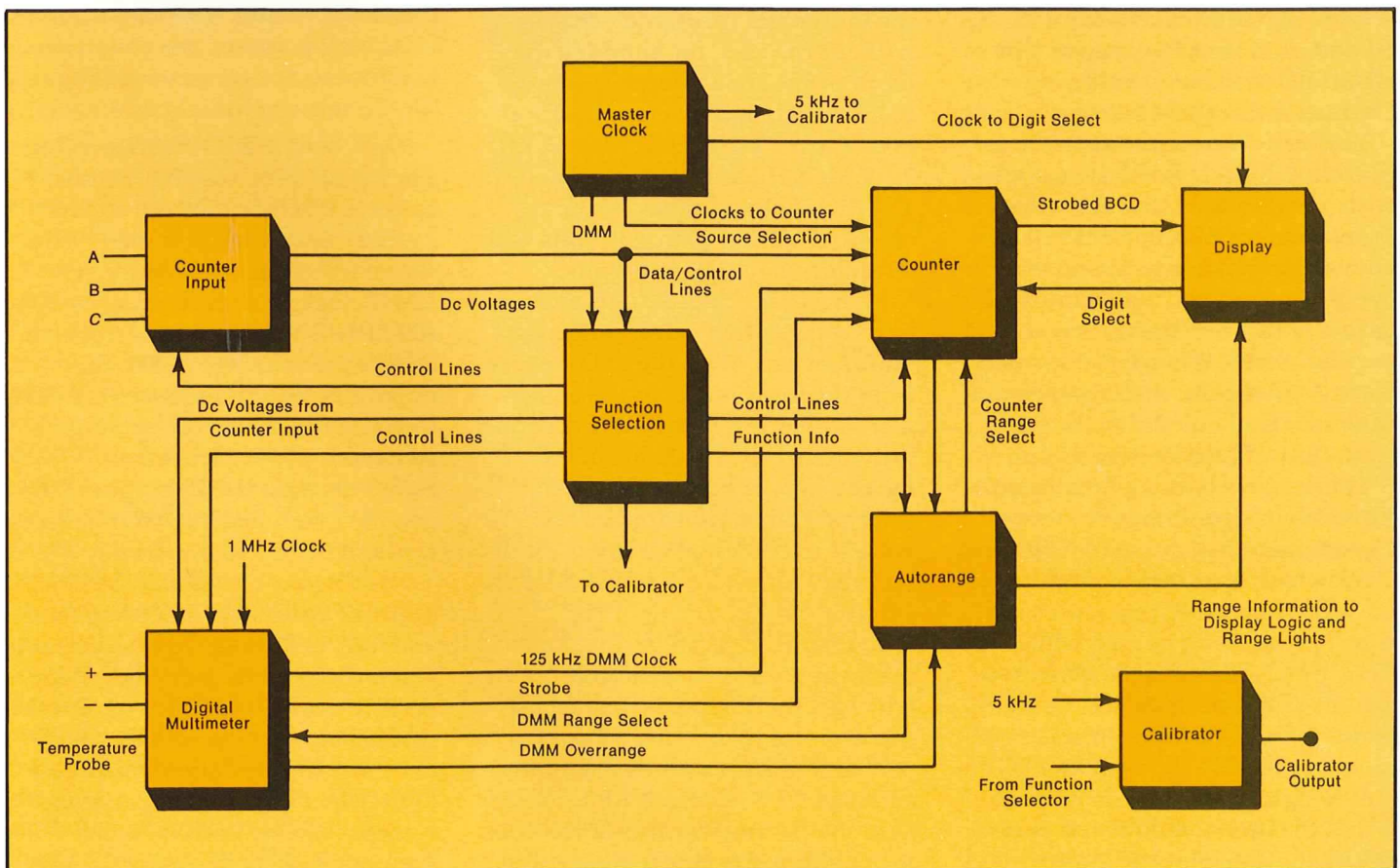

Fig. 4. A simplified block diagram of the 851.

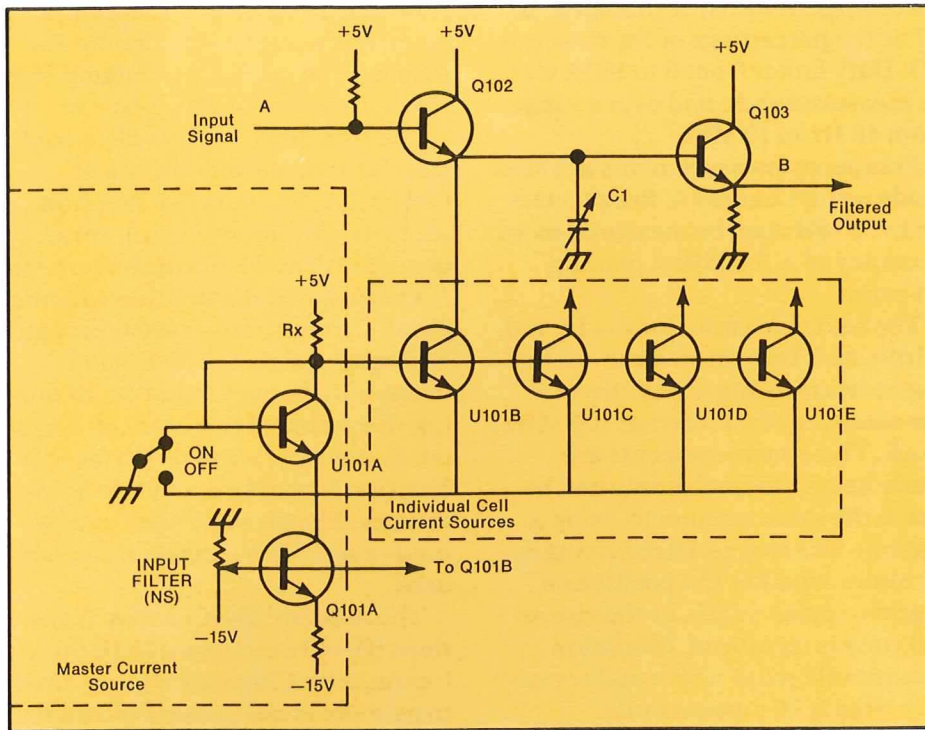

Fig. 5. Tracking of the eight filter cells is enhanced by placing individual cell current sources on a common substrate. Source current establishes discharge rate of C1 determining pulse width that is passed to point B.

lar with the exception that the transition function counts each time the A input signal traverses from LO to HI and each time it traverses from HI TO LO as determined by the Channel A threshold settings.

The transition counter can be a powerful digital troubleshooting aid with a little advance preparation. Transition counts can be taken on a known good instrument and recorded on the logic diagram. The gating points for Channels B and C are also noted. When a problem occurs, verifying the transition counts can often lead quickly to the problem area or faulty component.

The final two timing functions, Time (B→C) and Time (B•C) use Channels B and C to gate an internal clock which is counted and displayed. Time (B→C) measures the time between two events, while Time (B•C) measures the time two signals are in coincidence. Coincidence provides a quick means of making measurements of four different logic combinations: B and C, \bar{B} and C, B and \bar{C} , and \bar{B} and \bar{C} , simply by the appropriate choice of Channel B and C slope switch settings.

The four Threshold functions provide a convenient means of setting the individual threshold controls without the need for applying the input probes to a reference source. Each control has a detent position preset to a TTL level (0.7v for A LO, 2.1 V for A HI, and 1.4 V for B and C). The threshold voltages can be set over a range of -30 to +30 volts with a resolution of ± 10 millivolts.

Line voltage fluctuations and low line voltage often cause equipment malfunctions. With the 851 powered from the same outlet as the equipment under test, the Line V function provides a quick, safe means of measuring the line voltage. An internal connection applies line voltage to the DMM circuitry for direct readout; there is no need for an external probe.

Temperature is an optional measurement capability available on the 851. This is often the fastest technique to use in locating a faulty component. It is usually a comparison type test — looking for a component that is considerably hotter than its neighbor. Surface temperatures can be measured over a range of -55° to +150°C.

The block diagram.

A simplified block diagram of the 851 is shown in Figure 4. All of the measurements made by the 851 are converted to digital information and displayed on the 5-digit readout.

The Counter Input accepts signals from the Channel A, B, and C inputs. Depending on the function selected, the Counter Input supplies pulses to the Counter, gates the Counter while it counts internal clock pulses, or supplies dc voltages to the digital multimeter (DMM) for conversion to digital information. The DMM uses a conventional dual slope conversion technique.

Autoranging, an important feature of the 851, operates on all of the functions. It automatically selects one of eight possible operating ranges. Not all ranges are permitted for each function. Maximum and minimum range logic prevents automatic change to an illegal range. When switching from one function to another the range selected for the previous function may be illegal for the new function. An illegal state logic circuit senses this condition and presets the range to one suitable for the selected function.

The Counter is a 100-MHz counter. The signal to be supplied to this counter is selected by the counter source selector logic. It may be the signal from Channel A input, the DMM clock, or some frequency up to 100 MHz from the master clock. In all functions except DMM, the maximum count displayed is 99999. In DMM functions, the count is restricted to 19999. The binary-coded-decimal (BCD) output of the counter is strobed into storage registers and thence to the display.

The display consists of five seven-segment, half-inch, LED displays and four LED range lights. A BCD to seven-segment decoder driver converts the BCD information from the storage registers to signals which drive the seven-segment display. A digit-select logic signal gates one storage register and one seven-segment display at a time so only one BCD to seven-segment decoder driver is needed. Leading zero sup-

pression blanks leading zeros in the three left positions except for the first zero to the left of a decimal point. The display is updated three times a second for most functions and 100 times a second in Totalize.

The Master Clock oscillator is a crystal-controlled oscillator with 100 MHz output. The output is buffered and passed through a differential amplifier to shift the output from ECL to TTL levels and provide some waveshaping. One output of the differential amplifier is applied to a frequency divider string for division as needed to operate the various 851 circuits. The other output is applied to the counter source selection logic where it can pass directly to the decade counters for the timing functions.

Some unique circuitry

While many of the circuits in the 851 are typical of technology in common use today, there were some unique problems to be solved. The input filter is a good example.

Each input channel requires two input filter cells — one for positive going pulses and one for negative-going. (Channel A has an extra set of filter cells to accommodate the additional logic light function.) This means we need eight individual filter cells, all controlled from one front-panel control. The problem was how to get all eight filter cells to track.

The filter is a pulse-width, not a bandpass type filter. Basically, all eight individual cells are controlled by two adjustable current sources (one for each group of four cells). A current source and typical filter cell are shown in Figure 5. When the filter is turned on, current is supplied by Q101A, U101A, and U101B to Q102, establishing a charge on C1 that sets the output level at point B. Point B drives an output flip-flop. When the input signal at point A goes HI, Q102 turns on harder rapidly charging C1. The output at point B naturally follows. When input A steps LO, C1 starts to discharge at a rate established by the current supplied by the current source. Now if input A steps HI again

before point B goes low enough to trigger the output flip-flop, the negative going pulse appearing at the input will be ignored.

Since the current source is the key to determining the pulse width to be passed, the solution to getting the filter cells to track lay in supplying equal currents to each cell. This is achieved by placing the two master current source transistors, Q101A and Q101B, on a common substrate. The individual cell current sources are placed on two substrates containing five transistors each. The current in U101A will be mirrored in U101B, C, D, and E providing the same current to each of four cells. The capacitor, C1, is variable to compensate for small differences in currents and stray capacitances.

With the filter on and maximum "on" current being supplied from the master current source, the filter will pass pulses 50 ns or longer in duration, shorter duration pulses are filtered out. With the filter turned off, the emitters of the matched current sources U101A, B, C, D, and E are grounded and the source current is determined by the value of Rx. This current is much larger than was supplied by Q101A and enables C1 to discharge fast enough to pass all pulses delivered to the filter. With the filter off, at high current, the stored charge of Q102's, base-to-emitter junction helps speed up the discharge of C1 enabling very short pulses to be passed to point B.

The Peak Voltage detector circuitry in the 851 is of interest in that it does not use the conventional sample and hold approach; it requires a repetitive signal of 40 Hz or more. The circuit will respond to peak signals of 25 nanoseconds or longer. This requires the detector to respond rapidly to changes, and yet maintain the input level if no changes are occurring.

In Peak functions, the output of the input comparator goes to a Tek-developed hybrid circuit that stretches the input signal to about 50 microseconds. The output of the stretcher charges a capacitor in

small steps each time a signal is sensed, with the resultant dc voltage fed back to the inverting input of the input comparator. The feedback voltage will increase until it is higher than the peak of the signal, then no further increase will occur.

If the comparator input signal does not cross the inverted input level within 25 milliseconds, the capacitor is discharged rapidly via a timing circuit, pulling down the feedback voltage until the hybrid stretching circuit receives a signal. The feedback voltage will then be equal to the input voltage peaks. The dc level fed to the inverting input is filtered and routed to the DMM for conversion to a digital readout of the peak measurement.

Safety and reliability.

Much of the 851 design effort revolved around keeping power usage low to eliminate the need for a fan, and keeping reliability high. The majority of integrated circuits in the 851 are pretested and then soldered in. Extra space is provided for the DMM positions of the FUNCTION switch to prevent arc-over from high voltage inputs to sensitive circuitry. We have already discussed some of the steps taken to ensure meeting specifications over a wide range of temperature and humidity.

The DMM input and probe connectors are designed for maximum operator safety. Extra protection has been employed to prevent coming in contact with the signal voltage even when the probe is removed from the instrument while still attached to the circuit under test. The unique connectors for the counter probes also assure the probes will remain with the 851 instead of being borrowed for another instrument.

Summary

The 851 was designed to provide the customer engineer with a multi-function test instrument that would be easy to use, highly portable, highly reliable, and enable him to complete his service function on the first call in most instances. That's a big order. We're confident the 851 is equal to the task. 

851 Specifications

Electrical

Inputs

(ACV, DCV, Ω)

Resistance and Capacitance — 10 M Ω \pm 1% and approx 100 pF. Red to black terminal. (Volts only)

Max Safe Input Voltage (\leq 1 kHz) —

\pm 500 V (peak) red terminal to ground.
 \pm 500 V (peak) black terminal to ground.
 \pm 500 V (peak) red to black terminal.
 \pm 250 V (peak) red to black terminal in Ω function.

Resistance

Ranges — 200 Ω , 2 k Ω , 20 k Ω , 200 k Ω , 2 M Ω , 20 M Ω , and 50 M Ω .

Accuracy —

200 Ω , 2 k Ω , 20 k Ω , 200 k Ω : \pm 0.3% of reading \pm 4 counts (plus probe resistance).
 2 M Ω : \pm 0.5% of reading \pm 4 counts.
 20 M Ω : \pm 5% of reading \pm 10 counts.
 50 M Ω : \pm 10% of reading \pm 20 counts.
 Extended temperature range: add 0.2% on 200 Ω through 2 M Ω and 5% on 20 M Ω and 50 M Ω ranges.

AC Volts

(Average responding RMS calibrated for sine wave.)

Ranges — 2 V, 20 V, 200 V, and 350 V.

Accuracy —

2 V and 20 V:
 \pm 0.5% or reading \pm 4 counts, 40 Hz to 1 kHz.
 \pm 2% of reading \pm 4 counts, 1 kHz to 25 kHz.
 $>$ 9% full scale.

200 V and 350 V:

\pm 0.5% of reading \pm 4 counts, 40 Hz to 1 kHz.
 Extended temperature range: add \pm 0.2%.

DC Volts

Ranges — 2 V, 20 V, 200 V, and 500 V.

Accuracy —

2 V, 20 V and 200 V: \pm 0.1% of reading \pm 3 counts.
 500 V: \pm 0.15% of reading \pm 3 counts.
 Extended temperature range: add \pm 0.05%.

Normal-Mode Rejection Ratio

(Dc volts) — \geq 60 dB at 50 to 60 Hz. For peak amplitude \leq 5X full scale.

Common-Mode Rejection Ratio

(Ac and Dc volts) — \geq 80 dB at dc; \geq 60 dB at 50 to 60 Hz; \geq 52 dB on 350 V.

Line Voltage

Range — 90 to 132 V and 180 to 250 V.

Accuracy — \pm 3% of reading.

Temperature

Range — -55° to $+150^{\circ}$ C.

Accuracy — \pm 2 $^{\circ}$ C (0.01 $^{\circ}$ resolution). Extended temperature range: add \pm 1 $^{\circ}$ C.

Inputs

(3 probes; one for each channel A, B, C.)

Resistance and Capacitance — 10 M Ω and approx 12 pF.

Max safe input voltage — \pm 500 V at probe tip (\leq 50 kHz)

Threshold Levels

Variable (4 controls) range: \pm 30 V; settability \pm 10 mV.

Threshold Error — (Max difference between a displayed threshold voltage or TTL threshold voltage and the actual signal voltage at threshold crossing.) A Input (HI and LO THRESHOLDS): \pm 100 mV \pm 2% of threshold voltage \pm 3% of the signal voltage (p-p) for pulses at least 14 ns wide at the threshold. B and C inputs: \pm 100 mV \pm 2% of threshold voltage \pm 8% of the signal voltage (p-p) for pulses at least 14 ns wide at the threshold.

Extended temperature ranges: add \pm 20 mV \pm 2% of signal voltage (p-p).

TTL (nominal, in detent position) — Input A LO + 0.7 V; HI + 2.1 V; Input B and C + 1.4 V.

Input Filter

(Narrow pulse rejection) max input rep rate for pulse rejection = 20 MHz.

Range — off and 50 ns \pm 20% to $>$ 300 ns. Channel to channel delay mismatch: $<$ 100% of setting.

+ , - Peak Volts

Range — \pm 30 V.

Accuracy — \pm 2% of reading \pm 3% of p-p signal \pm 90 mV. Max time between recurrent peaks, 25 ms. Peak amplitude must be maintained for at least 25 ns. Extended temperature range: add \pm 1% of reading \pm 1% of p-p signal \pm 10 mV.

Frequency

Ranges — 100 kHz (1 Hz resolution), 1 MHz, 10 MHz, and 35 MHz.

Accuracy — \pm 0.005% of reading \pm 1 count.

Time Measurements

(Period, pulse width, transition time, time interval, and coincidence time.)

Ranges — 1 ms (10 ns resolution), 10 ms, 100 ms, 1 s, and 10 s.

Minimum Time Interval — 20 ns.

Accuracy — \pm 0.005% of reading \pm 1 count \pm Trigger Error.

Trigger Error —

$$\pm \frac{\text{Threshold Error}_1}{d^v/d^t \text{ of signal; at time start threshold}}$$

$$\pm \frac{\text{Threshold Error}_1}{d^v/d^t \text{ of signal; at time stop threshold}}$$

$$\pm \text{Input filter setting}$$

Counting

(Totalize, frequency ratio, events count, and transitions count.)

Range — 0 to 99,999

Max Input Frequency — 35 MHz (except 17.5 MHz for transition counting).

Accuracy — \pm 1 count, \pm A Input event or transition frequency multiplied by the Time Interval Trigger Errors.

Duty Factor

Range — 0 to 100%

Input Freq Range — 40 Hz to 10 MHz.

Min pulse width (HI and LO portions) — 50 ns.

Accuracy —

$$\pm 3\% \pm \frac{\text{Trigger Errors} \times 100\%}{\text{Pulse Period}}$$

$$\pm \frac{300 \text{ ns}}{\text{Pulse Width}}\%$$

Mechanical

Dimensions (approx)	cm	in
Width	33	13
Height	31	12
Depth	18	7
Weight	kg	lb
Net	6	13

Power Requirements

Line Voltage Range — 90 to 132 V or 180 to 250 V.

Frequency — 48 Hz to 440 Hz.

Power Consumption — 57 watts max.

Environmental Capabilities

Ambient Temperature — Operating: $+15^{\circ}$ C to $+40^{\circ}$ C. Nonoperating: -40° C to $+75^{\circ}$ C. Extended operating range: $+5^{\circ}$ C to $+50^{\circ}$ C.

Altitude — Operating: to 10,000 ft. Nonoperating: to 35,000 ft.

Vibration — Operating: 15 minutes along each of the 3 major axes, .06 cm (0.025 in) p-p displacement (4 g's at 55 Hz) 10 to 55 to 10 Hz in 1 minute cycles. After cycle vibration in each axis, hold frequency steady at 55 Hz for 10 minutes. All major resonances must be above 55 Hz.

Humidity — To 90% at 30 $^{\circ}$ C Tektronix Test Method #1 90% relative humidity at 30 $^{\circ}$ C for 4 hours.

Shock — Two shocks at 30 g's, 1/2 sine, 11 ms duration, each direction along each major axis. Total of 12 shocks.

EMI — Reference Mil Standard 461A-462 susceptibility as specified. Conducted emission, relax 10 dB. Radiated emission, relax 15 dB $<$ 100 MHz and relax 25 dB \geq 100 MHz.

¹See Threshold Error under Threshold Levels.

²Refer to the appropriate input (CH A, CH B, or CH C) for the measurement being made.

³See Trigger Error under Time Measurements.

Display

Readout

Type — 5 digits, fully buffered, 7 segment, 0.5" LEDs.

Polarity Indication — + for positive readings. — for negative readings.

Overrange Indication — Display flashes.

UP Ranging — Up ranging occurs at 100% of display range.

Down Ranging — Down ranging occurs at 9% of volts and ohms ranges, and 8% of time and frequency.

Range Indicators — LEDs show function ranges in Ω , k Ω , M Ω , MHz, kHz, ms, μ s and V.

Logic State Indicators — Red, yellow, and green LEDs show valid and invalid logic state inputs for CH A. Red and green LEDs show logic states above or below the threshold set for CH B and C. Any state change indication is sustained long enough to be visible.

Threshold Lock Indicator (LO $>$ HI) — Red LED indicates when CH A LO and HI thresholds are locked together (LO threshold setting is higher than the HI setting).

INCLUDED ACCESSORIES

Three signal probes (010-0280-00), two DMM probes (012-0732-00).

A New Concept in Data Representation: The Complete Integration of Graphics and Alphanumerics



Jack Liskear is Product Marketing Manager for the 4020 Series. During most of his ten years at Tek he served in various sales and service capacities with Tektronix, Ltd. in Australia. Returning to the U.S. he spent a year in the International Sales Office before joining the Information Display Group in his present capacity.

The use of computer graphics is nothing new to engineers, scientists and educators. For years they have been using graphics display terminals and computer controlled plotters for such applications as displaying three-dimensional structural models, drawing graphs of statistical functions, or illustrating the various concentrations of minerals in a soil sample.

Now with the increasing emphasis on analysis, planning, and data display in all corners of the business, educational, and governmental community, a whole new group of computer graphics users is emerging.

A new way of selling a concept

A few years ago, for example, the president of a large national bank came up with an innovative application for computer graphics. One of his responsibilities was to meet with prospective clients — people who were thinking of using the investment and trust services of the bank. After a few minutes of bantering dollar amounts and percentages about with these potential customers, however, he noticed that their interest would often begin to wain. He considered this problem and decided that the bank must find a more dramatic, easy-to-understand manner of presenting their banking and investment concepts.

On the advice of the head systems analyst at the bank, he authorized the purchase of a TEKTRONIX graphics display terminal and put a programmer to work writing a set of programs to display investment data.

A few days after the system was complete, the bank president was again asked to meet with a potential investor. This time instead of telling the bank's story, he and the prospective client sat down at the terminal together and he showed him the story. He first drew graphs on the display screen of various national financial statistics such as the GNP, inflation rate, and Dow Jones averages over the past 10 years. Then he displayed graphs of the financial ac-

tivity of his bank over this same time period — assets, sales, earnings per share.

Next he turned the keyboard over to one of the bank's investment counselors. He showed the potential customer a variety of investment plans that the bank could undertake for him, and graphs of the probable rate of return on his investment for each. At the same time, the investment counselor made copies of the graphs of each of these plans with a TEKTRONIX hard copy unit.

The result? The investor was delighted with the presentation and the bank got a new customer.

A picture makes all the numbers clear

Tektronix' graphic display terminal solved this bank president's problem for one basic reason. Graphic displays are much easier to interpret than lists of numbers. They show us immediately the trends, cycles, peaks and valleys. They allow us to quickly comprehend the situation, project into the future, and make decisions with confidence. They help us illustrate to others what we are doing, what we can do for them, or why a particular course of action is the best one.

Though the power of a graph or chart to quickly and clearly communicate information is well recognized, computer users in the past have shown more interest in the output of alphanumeric data from a computer, than in the computer's ability to create a graph of that data. When a graph was needed, they generally resorted to a pencil and a pad of graph paper.

But now, as the sizes of data bases and models are increasing, and the time frames for decision making are decreasing, financial analysts, business operations managers, and economists, as well as engineers and scientists, are beginning to look for quicker, more efficient tools for representing data.

An alphanumeric terminal or a graphics terminal?

To satisfy this growing demand for a

fast, cost-effective method of producing graphs and charts of data, Tektronix developed the 4025 Computer Display Terminal — a completely new concept in data representation. The 4025 is a raster scan (video) display terminal that provides all the features of a high performance alphanumeric terminal such as data entry, editing, and forms fillout, and also provides the ability to translate data quickly and clearly into graph or chart form. It is really two terminals — a graphics and an alphanumeric terminal — in one. It's a alpha terminal.

The 4025 is the first terminal with graphing capability designed specif-

wards expandable. Form fill out and graphing are offered as options to the 4025. They can be added to the basic terminal at any time.

Part of a growing family

The 4025 Computer Display Terminal is part of the new 4020-Series of raster scan terminals developed by Tektronix. The series also includes the 4024, an alphanumeric-only version of the 4025. The 4024 is provided for use in multiple terminal configurations, where graphics is not required at each work station.

Both of these terminals are microprocessor based systems, intended for use as an interface be-

Its relatively long persistence reduces flicker.

The keyboard features a standard office typewriter layout rather than the ASCII configuration. This layout was selected because it is more familiar to typists and other non-programmers. Also included on the keyboard is a numeric pad and 16 user definable keys. Four of these user definable keys are pre-programmed to provide the standard keyboard editing features — line delete, character delete, line insert, and character insert — at the touch of a finger.

Forms fillout for fast, accurate data entry

Forms fillout can be added to either the 4024 or the 4025 with the forms ruling option. Forms fillout is a feature found on alphanumeric terminals (see Fig. 3), which allows the user to divide the display screen into specific areas called fields. A field is described by its location, length, visual attributes, and logical attributes, and may consist of at most one line. The fields are set off with ruling lines and alphanumeric labels. A programmer generally constructs a form locally and stores it in the host. The terminal operator then recalls the form from the computer with a command typed on the keyboard. With the form displayed, the operator can enter data or tables quickly and efficiently merely by tabbing through the form. Virtually any source document can be re-created with this forms ruling package.

A complete selection of visual and logical attributes is included in the forms ruling package to allow portions of the screen to be highlighted or protected. The visual attributes include enhanced, blank, and blinking fields on the 4024, and on the 4025, inverted and underlined fields. Logical attributes include protected, modified, alphanumeric, and numeric only.

Easy graphing

The central theme in the design of the 4025 is to make it easy for the user to display graphics and al-

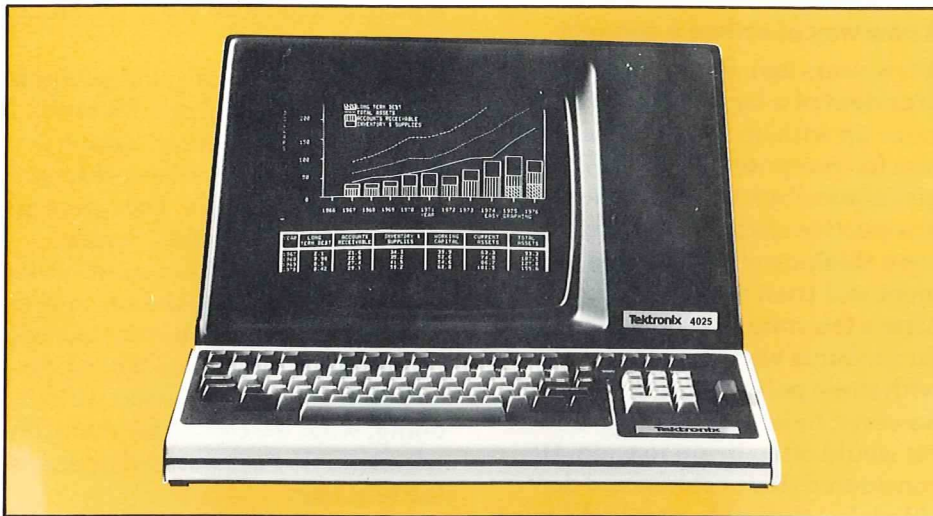

Fig. 1. The 4025 provides scrolling of both graphics and alphanumerics at the same time. Here both data and a graph of the data are viewed at the same time.

ically for the alphanumeric terminal user. It gives terminal users who are primarily interested in entering and manipulating words and numbers the added capability of displaying that information in easy-to-interpret graphs and charts. It answers the question, "How do I justify the expense of a graphics terminal that gives me graphs quickly and efficiently, but that I'll use only 20% of the time?" The answer is that the other 80% of the time the terminal can be used for data entry, editing, forms fill out, or on-line inquiry, just as is done with the strictly alphanumeric terminals available today.

The cost effectiveness of the alpha terminal concept is further enhanced by making the 4025 up-

tween a user and a computer. The keyboard is connected to the display unit by a thin flexible cable. The display unit contains the communications interface and possibly one or more optional peripheral interfaces, as well as the display electronics. Both the 4024 and 4025 provide full alphanumeric capability.

The bright, 11-inch diagonal video display provides the standard 80 characters across and an unmatched 34 lines deep, instead of the more common 24 lines. The 3 to 4, vertical to horizontal, ratio of the display area of the screen provides the ideal proportion for creating useful, attractive displays of any combination of graphics and alphanumerics. A P39 phosphor is used on the display screen. Its green shade reduces fatigue from many hours of viewing.

phanumeric. All the hardware and software has been designed with this concept in mind. To fully understand how this concept has been implemented, the performance of the 4025 can be divided into three functions: basic graphics, report generation, and hard copy.

For graphing purposes, the 4025 display screen is divided into 640 by 480 addressable points, providing a resolution of 71 addressable points per linear inch (28 points per centimeter). This resolution is more than sufficient for creating clear, precise line graphs, bar graphs, and pie charts.

To aid in making graphs, Tektronix provides its PLOT 10 Easy Graphing software package. This interactive package is highly user oriented, allowing even a novice terminal operator to generate complex graphs and charts with a minimum amount of training. Given a set of data, it is possible with this software package to generate a graph in a few seconds after answering only a few simple questions. Axes can be scaled in any units and increments. Graphs can be made up of solid and a variety of weighted and textured lines. Variable shading and textures are also available for bar charts. Pie charts can be drawn with one section of the chart pulled out.

A versatile report generation terminal

The 4025 is the first computer display terminal to truly integrate graphics and alphanumeric capability into one mainframe. It provides the ability to create a display that combines graphs and charts with alphanumeric text and tables, and further, to scroll the graphics and alphanumerics together.¹

The concept of scrolling is probably more familiar to users of alphanumeric terminals. It is the ability to review page after page of alphanumeric information as if it were on a scroll or roller. Most alphanumeric terminals that offer graphics can scroll alphanumerics only. When graphic information is



Fig. 2. The keyboard features a standard office typewriter layout plus a numeric pad and sixteen user-definable keys. In the LEARN mode, virtually every key can be programmed for another character or character string.

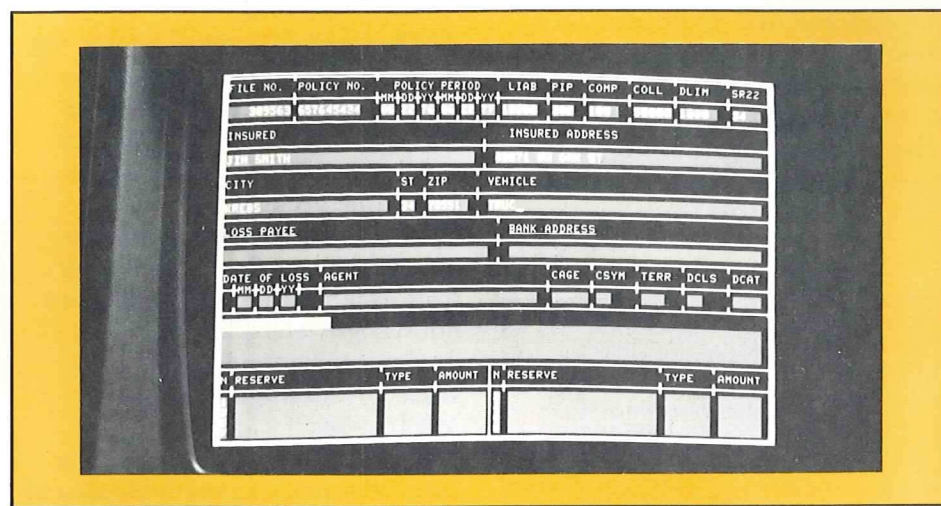

Fig. 3. A forms ruling option for the 4025 makes it a simple task to re-create virtually any source document.

displayed on such a system, it is on the screen in its set area all the time. If alphanumeric information is scrolled while graphic information is on the screen, the characters are written over the graph. The 4025 is the only terminal on the market to offer scrolling of both alphanumeric and graphics.

An example of the convenience of being able to scroll both alphanumerics and graphics is in the display of financial data. The graph of a particular function can be kept off screen and continually updated, while the user is filling out forms on the top part of the screen. When the user wishes to look at the graph, he merely scrolls it onto the screen.

Two or more graphs can be displayed on the 4025 screen at the same time, or a report can be created

that provides a number of pages of text and graphs combined. This feature is ideal for working with large bodies of text and graphics together. In this case the terminal user can define a different alphanumeric and graphics area for each page, fill in the words and graphs, then scroll through the various pages of data. Such reports are not only informative but also very attractive.

The size of the 4025 memory is the only limit to the number of graphs, charts, or text characters that can be displayed on the screen and stored in memory for later scrolling on screen. Both the 4024 and the 4025 offer a minimum of 4k of memory, expandable to 32k. With an average of 20 characters per line, up to 30 pages of alphanumerics and graphs can be stored in the full 32k memory.

Permanent hard copies

When its time to save or distribute a graph or report, a number of Tek-developed copy and graphic display peripherals, which can be connected to the 4025 through the peripheral interface, are available.

The 4631 Hard Copy Unit, for example, duplicates on-screen and buffered displays of alphanumerics and graphics — up to 53 lines by 80 characters on an 8½ by 11 inch piece of paper. TEKTRONIX Hard Copy Units are dry copiers, as opposed to a line printer or plotter. The 4631 produces a clear, sharp copy of the 4024 or 4025 screen in a matter of seconds. The ability to copy both alphanumerics and graphics makes these copies very useful for distribution to customers and management or to keep for records.

For detailed camera-ready graphics and alphanumeric output

— in 9 colors — the 4662 Interactive Digital Plotter can be selected. It produces ink copies of both graphics and alphanumerics. Copies up to 11 by 17 inches can be made on paper or film for use in an overhead projector. You can view and edit information with the 4025, then when it is corrected, plot it with the 4662.

The 4642 Printer is also available for copying alphanumerics output only. It is designed for use with either the 4024 or the 4025.

For large presentations, the 4024 and 4025 can be connected directly to a video monitor or large screen video projector.

Direct interfacing

All the standard type of interfacing, such as RS-232C and current loop, are available for the 4020-Series terminals. Both the 4024 and the 4025 are easy to interface to any computer, because they use English-formatted command sequences. In an effort to get away from escape sequences, which are not recognized by all host computers, each command is represented by an English-language ASCII string.

A polling interface and polling controller are also available that allows one 4025 and up to seven additional 4024s and 4025s in any combination to be polled by the host computer. The polling controller is housed in the first 4025, so at least one 4025, is required to operate the polling network.

The first polling controller offered for use with the 4020-Series terminals provides an interface to an IBM 370 computer. It causes the 4024s and 4025s to emulate an IBM 3270 terminal. The polling controller also includes an RS-232C peripheral interface. With this interface, a single hard copy unit or plotter can be used to copy data from any of the terminals connected to the polling controller.

Customizing the 4020-Series

A number of other features are provided that allow the 4020-Series terminals to be used for specialized

applications. Using the LEARN mode, virtually every key on the keyboard — 81 keys all together — can be programmed for another character or character string, which is then inserted whenever the key is struck. This allows commonly used character strings, words, or commands to be invoked with a single key stroke.

Another useful feature is the ability to divide the display screen into two areas: the workspace and the monitor. The operator controls the total number of lines assigned to each area. 30 lines may be assigned to the workspace area, for instance, and 4 lines to the monitor area. The workspace is generally used for forms fillout, graphics, or for entering and examining alphanumeric data. The monitor space is used for special communications between the computer and the operator. It may not contain forms or graphics. When a user is entering data into a form in the workspace, for example, and the computer wishes to send the user a message, the message is sent to the monitor area. The monitor area provides a convenient method of communicating with the computer without interfering with a form or graph on the screen.

Gralpha: a concept for today and the future

Whether its business or financial management, government agencies, or the more traditional users of computer graphics — engineers, scientists, and educators — the demand for fast, efficient methods of turning alphanumeric data into easy-to-interpret graphic displays is growing at a rapid pace. With its upward expandable packaging and full performance alphanumerics and graphics, the 4020-series has met this demand and will continue to meet it well into the future.

The gralpha terminal is a cost effective concept; a cost effective solution to the problem of data representation. 

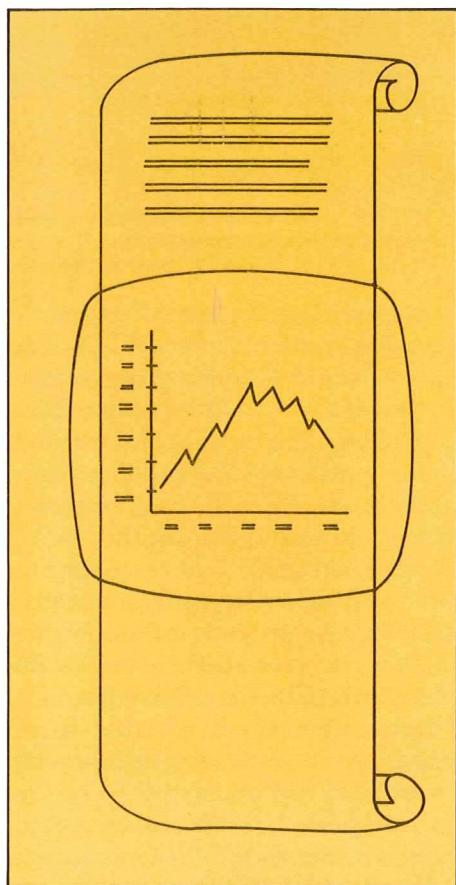

Fig. 4. The concept of scrolling is presented in this artist's sketch showing graphics on-screen with data off-screen available for instant viewing.

¹See the article on page 13 of this issue of Tekscope for more information on the ability of the 4025 to scroll graphics.

The Virtual Bit Map Brings High Resolution Graphics To the Alphanumeric Terminal User



Stan Davis has been involved with computer terminal design since coming with Tektronix in 1968. He worked on the keyboard and other circuits for the T4002, was project engineer on the 4023, assisted on the 4081 program, and was project leader for the 4025 program. He gave a paper on the virtual bit memory map at MiniMicro in Anaheim in December. Stan received his BSEE and BA from Rutgers University in 1964 and an MBA from University of Portland in 1975.

In the past, computer display terminals have, in general, been designed either for graphics — graphs, charts, three-dimensional models, maps, etc. — or alphanumerics — data entry, text editing, forms fill-out and on-line inquiry. Now with low cost video chips, microprocessors, and the declining cost of memory, it is possible to produce a low-cost, raster-scan (video) terminal that combines the two functions in one low cost package. This new category of terminal is called a gralpha terminal.¹

In designing Tektronix' version of the gralpha terminal — the 4025 Computer Display Terminal — we had two design criteria. We wanted to offer the user as much flexibility as possible in creating combined displays of graphics and alphanumerics. For example, we wanted to be able to place graphics anywhere on the display screen and to be able to scroll both graphics and alphanumerics. The second criteria was to be able to handle almost all conceivable graphing needs with a moderate amount of graphics memory. These needs included both the ability to create complex graphs, and the ability to store a number of graphs in the graphics memory at one time. Such a terminal could be used for graphic analysis and data display as well as for generating reports that combine alphanumeric text and graphics.

Bit map graphics

Meeting these criteria called for an interesting variation in the traditional method of storing graphics. Most raster-scan terminals that offer graphing capability use a bit map for storing the graphics data. With a bit map, one bit in the graphics memory is assigned to each addressable point on the display screen — one bit for each dot. The graphics memory is then scanned one row of dots at a time to create the graphics display. The scanning is done with a simple counter. No display list or pointers are used.

To combine alphanumerics with the graphics display, a separate al-

phanumeric generation system is provided. Some sort of mixing technique is then used to combine the graphics with the alphanumerics. A video mixer is one example.

The most significant drawback of the bit map method of storing graphics is that the graphics can not be scrolled. The display window of the bit map is defined as the boundaries of the display screen, and can not be moved. Another limitation is that a bit map memory is a very inefficient way of storing graphics. A large percent of the memory is used to store spaces or voids in the graphics area.

Displaying words and numbers

In order to make more efficient use of graphics memory and to allow scrolling of graphics on a raster scan terminal, a new technique for storing graphics data called a virtual bit map was developed.

To better understand the virtual bit mapping technique, it is helpful to understand how a raster scan terminal generates alphanumeric characters (see Fig. 2). The display screen is divided into alphanumeric cells which are 14 dots high by 8 dots wide. 80 of these alphanumeric cells fit together side by side to form a row of characters. With the 4025, up to 34 rows of alphanumeric cells can be displayed at one time on the display screen. A dot is equivalent to the width of one raster line, so that it takes 14 raster scans to create one row of characters.

The 4025 uses an interlaced raster scan system. Every other row of dots is thus scanned with each complete scan of the display screen.

The alphanumeric data to be displayed comes from the host computer, a mass storage device, or the terminal keyboard. A microprocessor in the terminal uses this data to create a display list, which combines ASCII character codes, character set attribute codes (upper or lower case), and field attribute codes (blinking field, enhanced field, etc.).

The display controller scans the display list one row of characters at

a time and uses each ASCII code for fetching a dot matrix character from a character generation ROM, which is then displayed on the crt screen.

The virtual bit map technique

Creating a display of alphanumerics and graphics with the TEKTRONIX 4025 is somewhat like putting together a jigsaw puzzle with the help of a computer. Using a software program such as the PLOT 10 Easy Graphing software package, the 4025 user initially establishes a graphics region on the display screen. The rectangular graphics region can be placed anywhere in the display area. The remainder of the display area is then considered alphanumerics region.

The microprocessor then further divides the graphics region into graphics cells. A graphics cell is the same size as an alphanumeric cell — 14 dots high by 8 dots wide. When the microprocessor receives information from the host computer telling it the size and location of the graphics region, it uses a firmware program to create a uniform array of dummy address pointers in the display list. Each of these dummy addresses potentially points to one graphics cell of information stored in the graphics memory.

Next the 4025 operator defines the graph parameters and inputs the data to be graphed. Using an incremental plotting algorithm, the microprocessor writes the dot pattern for the desired graph in the graphics memory. A writable RAM is used for the graphic memory. It has been designed to be written into by the microprocessor as an I/O device. Its output is designed to look like that of the character generation ROM.

The addresses for each of the graphics cells that contain graphics information are then exchanged for dummy addresses in the display list. Those graphics cells that do not contain graphics information appear in the display list as spaces.

Alphanumeric codes are also written in the display list just as with an alphanumeric only terminal. The resulting display list is made up of codes to generate specific characters

with the character generation ROM and addresses in the graphics memory for the dot pattern to fill up specific graphics cells.

Using the display list as a guide, the display controller puts together the alphanumeric-graphics puzzle from the top of the display to the bottom. When the display controller scans the display list and comes to a part of the list that has been designated as graphics, it goes to the graphics RAM. The pointer in the display list points to a group of bytes that designates the dot pattern for the part of the graph that is contained in that particular graphics cell.

This technique of allocating graphics memory is called a virtual bit map because it appears to the terminal user that every address-

able dot location in the graphics area is assigned a bit in the graphics memory. In reality, only those graphics cells in the display area that actually contain graphics information are assigned bits in graphics memory.

A virtual bit map thus makes more efficient use of memory than the traditional bit map technique, where each addressable dot location in the display area is allocated a place in the graphics memory, even if the actual graph takes up only a small amount of display area. A complex graph, for example, taking up the entire display screen can be stored in 16 kilobytes of graphics memory using the virtual bit map technique of storage. With the traditional bit map technique, this graph requires twice as much memory. The

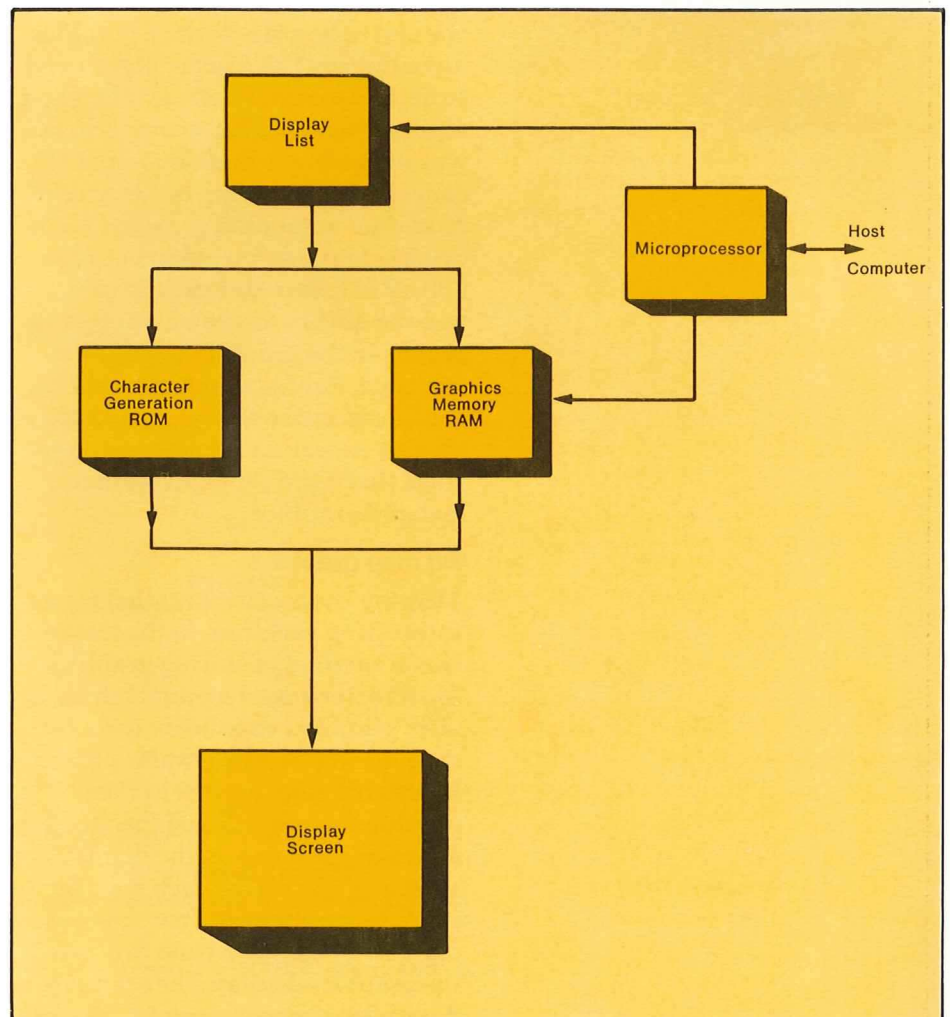

Fig. 1. Simplified block diagram of the 4025. The Display List contains alphanumeric codes for the character-generation ROM and addresses in the graphics memory for the dot pattern in specific graphics cells. Using the Display List as a guide, the Display Controller assembles the display a line at a time. The display is interlaced.

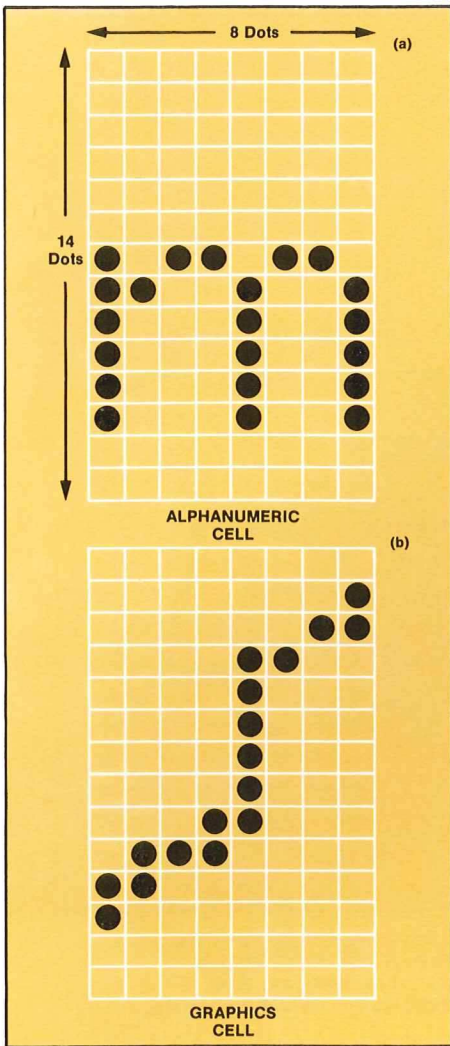

Fig. 2. In the 4025, graphic data is stored in graphic cells (b) containing the same number of elements as alphanumeric cells (a). Graphic memory is required only for those cells containing graphic data; empty graphic cells are treated as spaces. This greatly reduces the memory required for graphics.

savings in memory is the greatest for small, simple graphs.

Report generation

The virtual bit map graphing technique also solves the problem of being able to scroll graphics. The display list can hold more information than can be displayed on the screen at one time. Scrolling and paging are used to make it all visible. Scrolling is accomplished by starting the field at a point in the display list that is designated as being a fixed memory location — the beginning of a line. To scroll the display, the display controller sequences through fixed memory locations — line by line — or jumps 34 lines at a time — paging. The

graphics scroll with the alphanumeric, since the graphics information is contained in the list the same as the alphanumeric.

Store two or more graphs

More than one graph can be displayed on the screen at one time. The microprocessor merely designates a new section of the graphics memory for each additional graph. The amount of graphics and alphanumeric that can be stored in the 4025 at one time is determined by the size of the display list memory and the graphics RAM. 4 kilobytes is the standard size for each of these memories in the 4025, but each can be expanded to 32 kilobytes. It is thus quite possible to create a graph that extends vertically off the page and can only be viewed in its entirety through scrolling or hard copy (if it is 53 rows or less).

Create special characters

Besides containing graphs, the graphic memory can also be used to store user-defined characters, character sets, or symbols not found in the character ROM. Under the di-

rection of user software, the character or symbol is merely written in one of the graphics cells. It can then be inserted anywhere in the display list by specifying the addresses of the graphics cell.

Summary

The demand for an easy-to-use grapha terminal that can display graphs, charts, and alphanumeric text in an attractive format is on the increase. It is the virtual bit map method of storing graphics that makes this kind of a terminal possible.

The ability to store a number of graphs in the graphics memory and to construct a multi-page report that combines text and graphs on each page gives the 4025 considerable flexibility for use in data analysis, report generation, and data display. Scrolling both graphics and alphanumeric makes the 4025 extremely convenient to use, allowing both text and graphics to be quickly reviewed and edited.

¹See the article on page 9 of this issue of Tekscope for a discussion of the grapha concept.

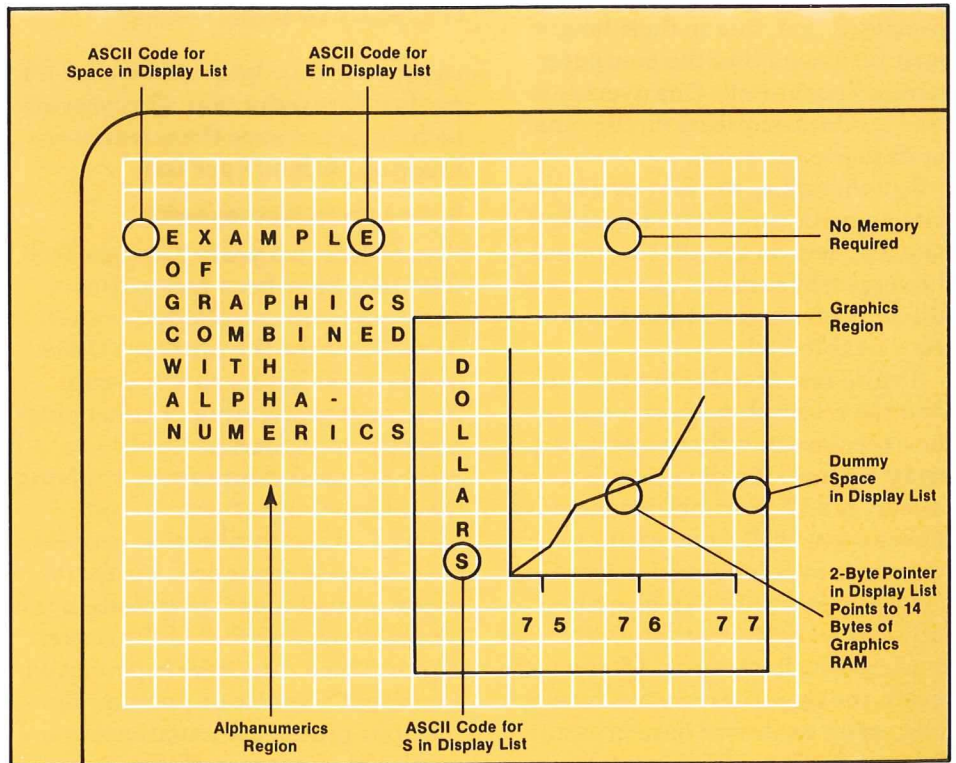

Fig. 3. Drawing depicting a portion of the 4025 display area containing both graphics and alphanumeric. The screen is divided into 34 rows of 80 cells each. Data for the graphic cells are stored in RAM. Alphanumeric data are stored in a character-generation ROM.

Evaluating Test Data with Computer Graphics

Computer display terminals have a versatility that extends far beyond final-data presentation. One of the more effective applications of the terminal is to use it for a preliminary view of raw data and any intermediate stage of data reduction. This previewing technique can be an impressive diagnostic indicator, time saver, and data compactor.

Data previewing at Georgia Tech.

Data previewing is being utilized at the Georgia Institute of Technology, where the Aerospace Engineering Department is using a TEKTRONIX 4012 Computer Display Terminal to make a preliminary analysis of the data acquired from impedance tube measurements during the burning of solid-propellant rocket fuel. This previewing is done before investing time in extensive data reduction and data presentation.

Aerospace scientists at the Institute are processing information with a minicomputer-based data acquisition system. The computer program is divided into two sections (overlays) that, due to their length, must be placed into the computer memory separately. One overlay is used for data acquisition, the other for data presentation.

By concluding the first overlay — data acquisition — with a graphed data preview on the 4012 terminal, the research team can quickly ascertain if the desired test conditions were established.

If valid test data is not attained, then the research team can repeat the experiment without a software delay, because the data-acquisition overlay is still in computer memory. If necessary, preliminary runs to verify proper instrumentation function and test conditions can be made rapidly and easily with the 4012 preview-display format. After a test series, the scientists can load the long, more extensive data presentation overlay into the computer, confident that the desired test conditions were obtained and that only

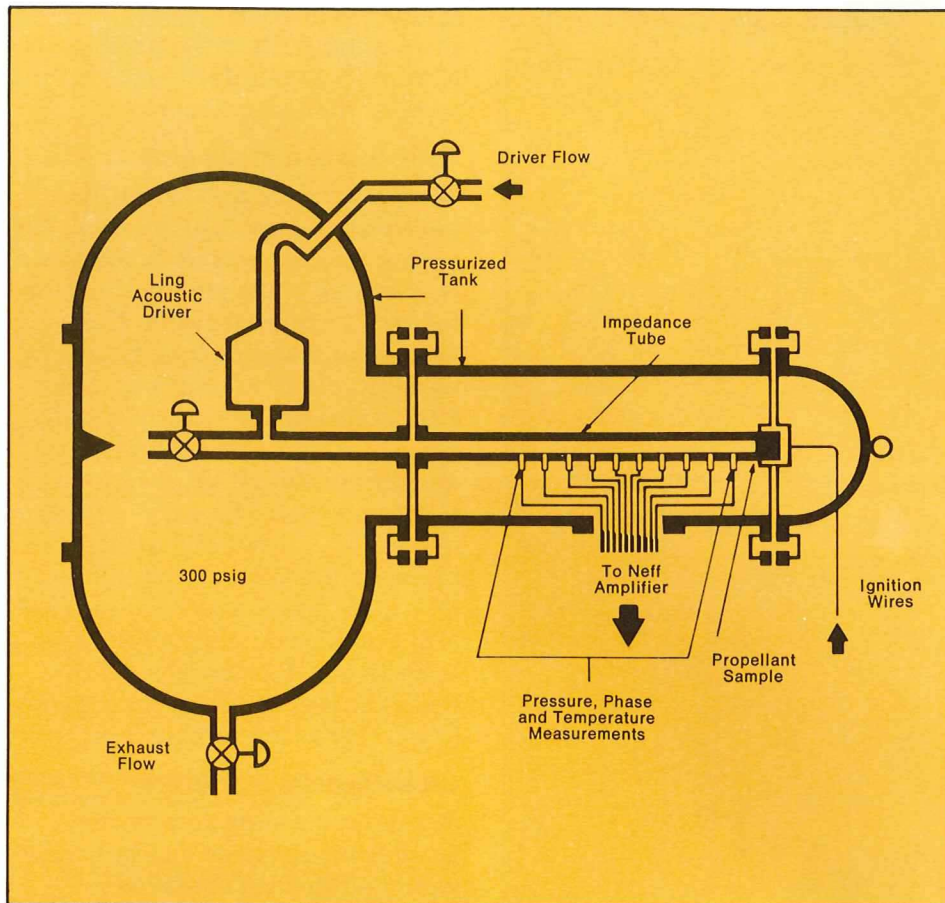

Fig. 1. To minimize pressure differences across the delicate transducer diaphragms, the impedance tube is enclosed in a pressurized tank or shell. A sound source of known frequency and the propellant sample are placed at opposite ends of the tube. After propellant ignition, the amplitude and phase of the resultant pressure oscillations and the temperature in the tube are monitored.

significant raw data will be used for further data reduction. This preview technique can save the scientists as much as 1½ hours per test.

Solid-fuel rocket research

For the last two years, Georgia Tech scientists have been conducting basic research on solid fuel rocket propellants for the Air Force Office of Scientific Research. Primarily, they are investigating the phenomenon of combustion instability in solid-fuel rocket motors by studying the interaction between sound waves and the combustion process. When a solid propellant burns, it produces turbulent conditions in the combustion chamber of the rocket motor. This turbulence is perceived as noise. The noise or pressure fluctuations produce fluctuations in the combustion process. If the interaction between the pressure and combustion oscillations are in phase, the

pressure waves tend to amplify the combustion oscillations, which in turn, amplify the pressure fluctuations. Undamped, this disturbance can seriously impair the effectiveness of the rocket engine performance and even cause failure of the combustion chamber, usually between 10 to 10,000 Hz.

At Georgia Tech, Dr. Ben T. Zinn, the principal investigator; two research engineers, Dr. William Bell and Mr. Bob Daniel; and a graduate student, Mr. Mohammed Salikuddin have spent three years exploring some of the important parameters of this problem and creating a viable testing procedure.

Testing fuels in an impedance tube

The experiments are centered around the study of the combustion process using an impedance tube at pressures from 15 to 350 psig. The tube is a 6-foot-long stainless steel

pipe capable of testing propellant samples two inches in diameter. Although solid-fuel rocket chambers are often designed in gargantuan sizes (10 to 15 feet in diameter), the diminutive impedance tube provides an effective testing apparatus that can be used at minimum cost and maximum safety.

At the beginning of a test, a solid propellant — portioned to burn for approximately 4 seconds — is placed on a steel plate that is secured inside one end of the impedance tube. At the other end, an electropneumatic acoustic driver introduces sound into the tube at a controlled frequency (Figure 1).

The fuel sample is ignited at the initiation of the testing procedure. The sound from the acoustic driver sends incident waves traveling down the impedance tube to the combustion area. There, the wave interacts with the combustion process and is reflected back towards the driver. The reflected and incident waves combine to form a standing wave along the length of the tube (Figure 2). The amplitude and shape of this standing wave is dependent upon the amount of sound absorbed or amplified by the combustion process and upon the phase relationship of the incident and reflected waves.

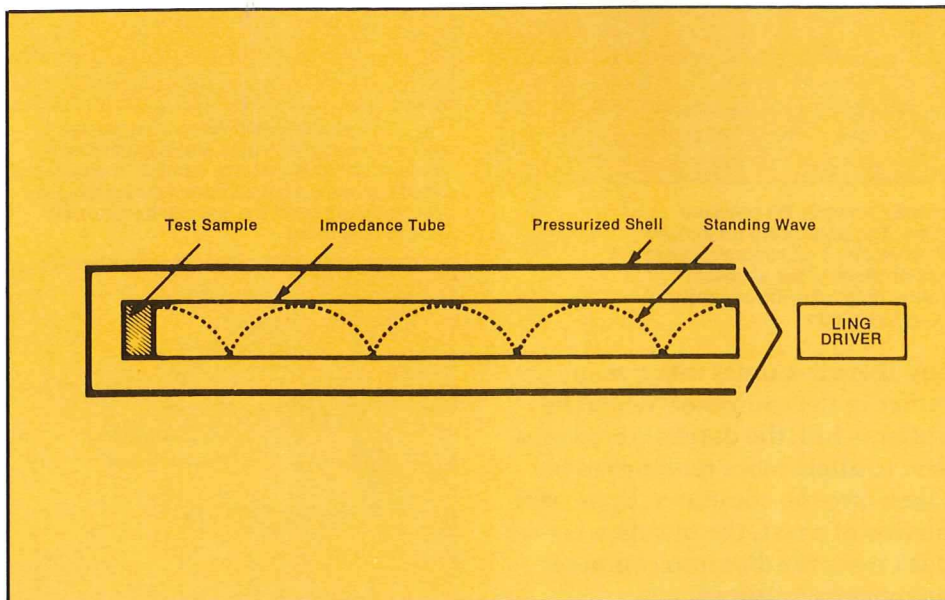

Fig. 2. The shape of the standing wave can be reconstructed by analyzing the amplitude, phase, and temperature measurements taken along the impedance tube. The standing wave shape makes it possible to determine how much the combustion process amplified or attenuated the acoustical oscillations.

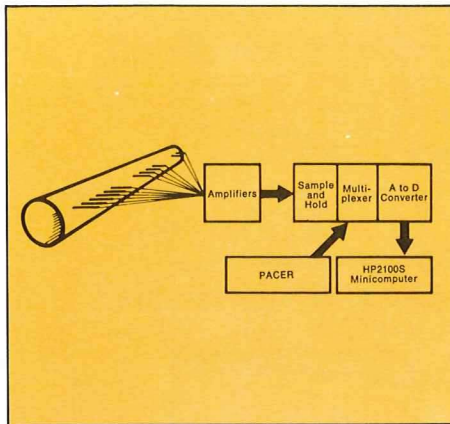

Fig. 3. The signals from the pressure transducers and thermocouples are amplified and simultaneously sampled and held. A multiplexer samples each data channel, and the voltages are converted to digitized form. The sampling rate is controlled by the pacer. The raw signals are recorded on a disc, using the computer as a buffer.

Measuring the standing wave

The scientists use transducers (condenser microphones) to measure the amplitude and phase of the standing wave at different tube locations. They can then determine the ratio of the incident to the reflected wave. Fourier analysis is applied to filter the pressure signal at the test frequency from harmonics and noise.

Testing restrictions caused by temperature changes

The amplitude of the sound in the impedance tube is fluctuating wildly because there is approxi-

mately a 3,000° increase in temperature from ignition until steady burning is achieved. Once the temperature stabilizes, there is only one or two seconds where reliable, steady standing-wave readings can be obtained.

Test equipment

The Aerospace Engineering Department's data acquisition equipment consists of a...

- Neff amplifier;
- Preston GMAD-11 twelve-channel analog to digital converter with multiplexer;
- Hewlett-Packard 3320-A frequency synthesizer;
- TEKTRONIX 4012 Computer Display Terminal;
- and a Hewlett-Packard 2100S 24K memory computer with two direct memory access channels, disc storage with a capacity of 2.5 million words, and a transfer rate of 128,000 words per second.

Data acquisition

Data from up to ten transducers and two thermocouples are taken during an experiment. After being amplified by the Neff amplifier, the transducer signals appear at the input of the A to D converter in a $\pm 2\frac{1}{2}$ volt range (Figure 3).

Data Analysis

The research team previews the experimental data with two displays on the 4012 terminal to determine the valid data ranges (Figures 4 and 5). The displays plot the standing wave's amplitude and phase relationship versus time as recorded by each transducer. The time period of steady combustion can be determined by a visual inspection of the display. The terminal keyboard is used to communicate the valid beginning and ending test parameters to the computer; subsequent data presentation and analysis is restricted to this data segment (Figure 6).

There, the analog signals are converted into digital data that are stored in 8-bit bytes (1 bit to indicate the polarity and 7 bits for voltage). The A to D converter compacts two

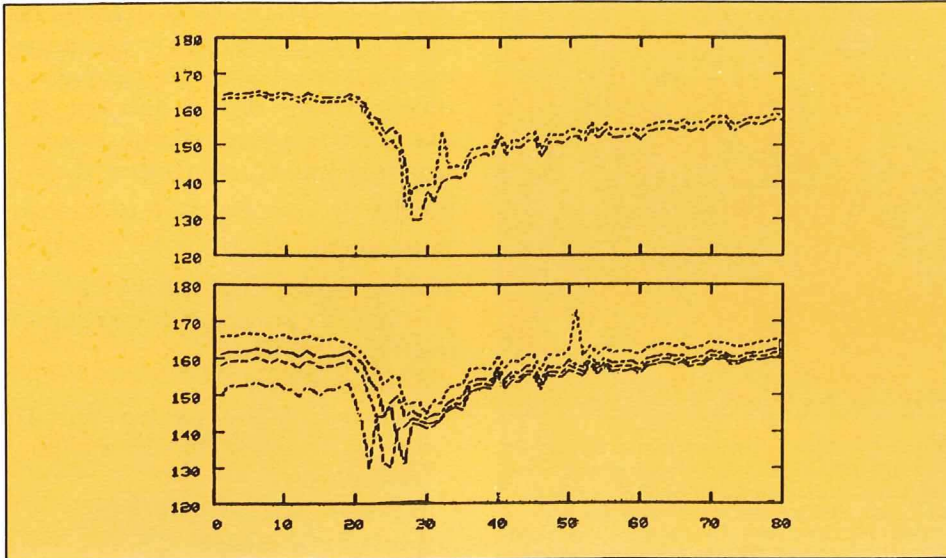

Fig. 4. These graphs displayed on the 4012 terminal and copied on a TEKTRONIX 4631 Hard Copy Unit show the oscillating pressure amplitude in decibels versus nondimensional time at six axial stations along the impedance tube. The propellant is ignited at time $T=20$; the increase in temperature causes fluctuations in the amplitude until time $T=40$. After this point, the temperature reaches a constant level, the amplitude variation diminishes, and desirable test conditions are achieved from $T=40$ to $T=80$.

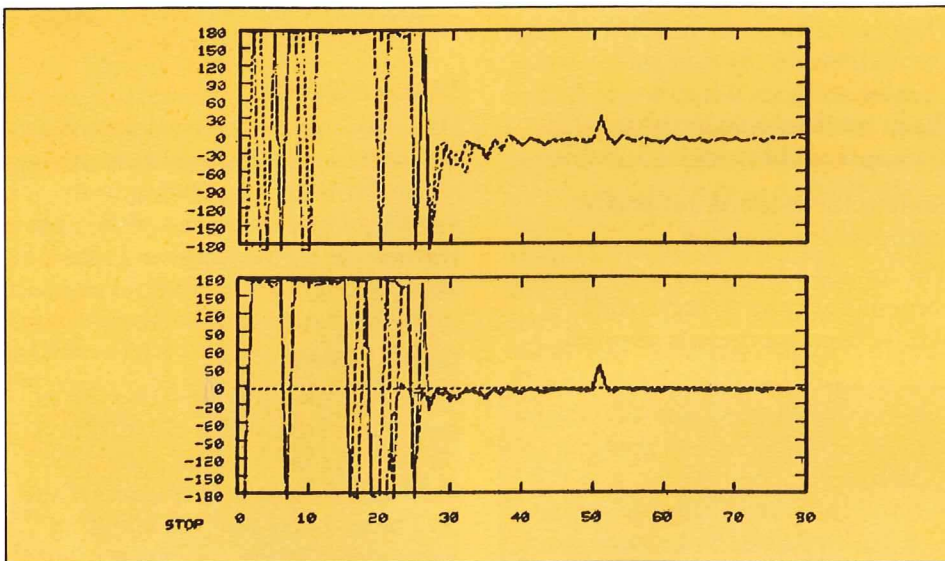

Fig. 5. These plots show the corresponding phase differences between the pressure oscillations at the six axial stations along the impedance tube. The phases are referenced to one of the transducer signals. Before ignition, the oscillations are ± 180 degrees out of phase with the reference signal. After ignition, the pressure oscillations are almost in phase. By measuring these phase differences, it is possible to determine the capability of the propellant to drive unacceptably large oscillations in a rocket motor.

8-bit bytes into a 16-bit word. Six words then, represent one measurement sample.

The frequency synthesizer acts as a pacer and controls the rate at which the A and D converter digitizes and stores the data. This rate can be set to optimize the accuracy of the amplitude and phase data for a given frequency. The multiplexer sequentially stores the digitized data from the pressure transducers

and thermocouples into a memory buffer in the computer. When the buffer is full, the data is stored on a disc to allow more readings to be taken into the computer. Upon completion of a test, the raw data is read back from the disc into computer memory as required.

Data presentation

After 4012 terminal previewing has isolated valid raw-data parameters,

the long data-presentation overlay is loaded into the department's minicomputer (Figure 7). The output of this program is steady-state amplitude, phase, and temperature information from the experiment. This data is graphed on a plotter and listed on a teletype. Selected data are taken and transmitted to the university's CYBER 70 computer system for final analysis and presentation. Essentially, the CYBER 70 analyzes the amplitude, temperature, and phase data; performs a least squares curve fit; and indicates on a line printer how much the sound is increased by the tested propellant.

Summary

Data previewing is an important time and cost saving technique for this and many other applications. This particular application calls for a terminal that is reliable, versatile, and reasonably priced. The 4012 meets all of these requirements.

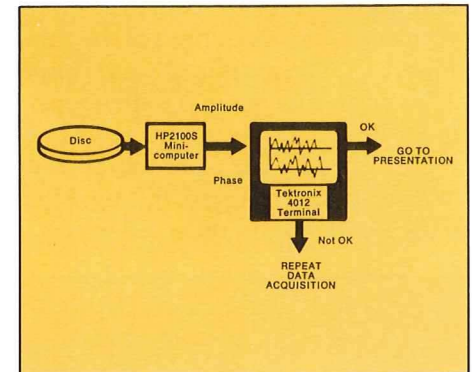

Fig. 6. The raw digitized data are converted to amplitude and phase data and displayed on the Tektronix computer display terminal. If proper test conditions were not established during the 4 second propellant burn, the test can be rerun with minimal time delay.

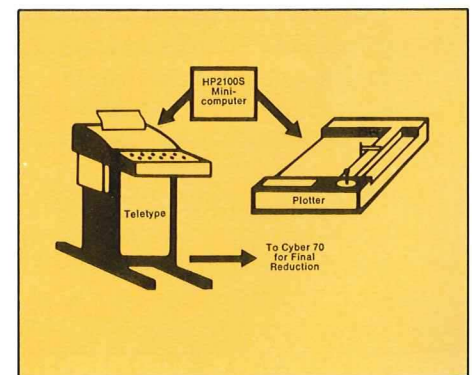
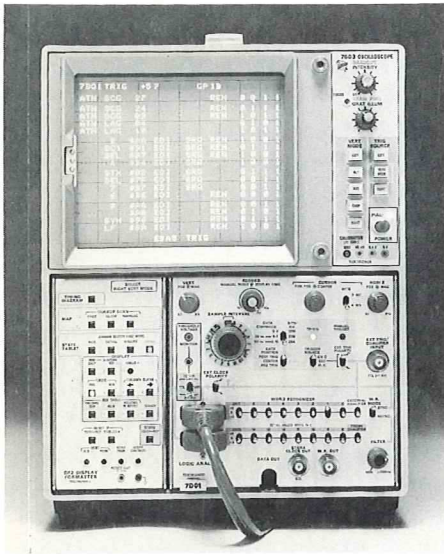

Fig. 7. Amplitude, phase, and temperature data versus time are plotted and printed. Final data analysis to reconstruct the standing wave is performed on a CYBER 70 computer.

New Products

The DF2 Display Formatter with 7D01 and 7603



New Display Formatter Offers GPIB ASCII Capability

Digital designers can now look at disassembled GPIB (IEEE Standard 488-1975) activity with the TEKTRONIX DF2 Display Formatter. The DF2 also formats data stored in the 7D01 memory in ASCII format with further decode in hexadecimal, binary, or octal notation on the same display.

The DF2 works as a companion to the 7D01 Logic Analyzer. Additional display formatting capabilities include: timing, mapping, hexadecimal, octal, and binary. An automatic data comparison feature enables the user to catch intermittent faults.

Synchronous operation enables the user to view blocks of the 256 GPIB instructions stored in the 7D01 memory, 17 instructions at a time. Disassembled instructions of activity on the data bus, transfer bus (handshake lines), and management bus (control lines), are displayed in IEEE 488 mnemonics. Asynchronous GPIB measurements can be displayed in a timing diagram when monitoring handshake line activity. The DF2's GPIB capability enables digital designers to design, troubleshoot and integrate GPIB systems easier and simpler.

GPIB or ASCII modes are selected from the DF2 front panel by pressing

P6303 Dc Current Probe with AM 503 Amplifier

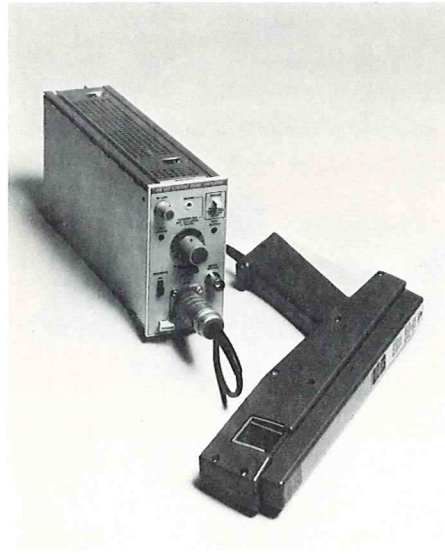

a MENU button.

Included with the DF2 is a GPIB probe adapter with standard IEEE 488 connector and quick connection to the P6451 Probe head.

Dc Current Measurement To 100 Amps

The P6303 is a new current probe designed to make ac and dc current measurements to 100A, 500A peak.

The current measurement system consists of the P6303, the AM 503 Current Probe amplifier, a TM 500 Power Module and any oscilloscope with at least a 50-MHz bandwidth and 10 mV/div vertical sensitivity.

With its large 1 x 0.83 inch (2.54 x 2.11 cm) jaw opening, the P6303 can make accurate dc coupled current measurements of large conductors which previously were not possible. The spring-loaded jaw slides open for placement around the conductor. There's no need to break the circuit under test. For differential or sum measurements, merely place the conductors in the probe jaw in the proper phase.

The P6303 is highly recommended for measuring current in X-ray tubes, SCR motor controls, industrial controls and power supplies. It is especially useful when making measurements at high impedance points or with current dependent devices.

The New C-28 Crt Camera

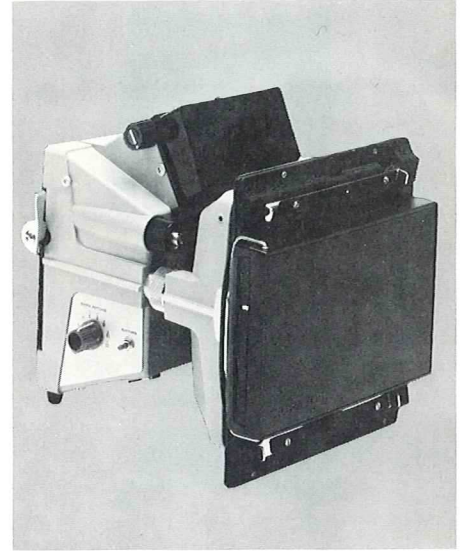

C-28 Camera Features Electric Shutter

The new C-28 Crt Camera features an electric shutter, changeable magnification, a quality lens, and mechanical rigidity.

The electric shutter allows remote operation for operator convenience or system control of the camera, and provides accurate, repeatable exposure times. The shutters' input trigger is TTL-compatible to simplify interfacing to the user's system. Reliability of the electric shutter is far superior to that of mechanical shutters.

Magnification can be changed from 0.67 to 0.85 to permit full-frame photographs of both 8 x 10 cm and 10 x 12 cm displays. This is accomplished by changing spacing rings on the easily disassembled lens barrel. The economical f2.8 lens provides the performance needed in general crt photography.

The C-28 offers outstanding strength in its frame and crt bezel attachment mechanism.

Two film backs are included with the C-28 — a Graflok 4" x 5" roll film back and a Polaroid Type 405 back modified to fit directly onto the Graflok back. This special interface allows the user to quickly switch from negative film to Polaroid.

Medical diagnostic applications

New Products

8001 Microprocessor Lab with Optional CT8100 Crt Terminal

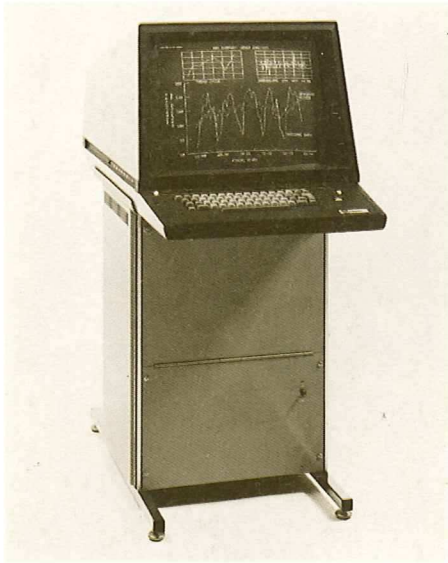

including ultrasound, nuclear medicine, and computerized tomography are excellent examples of applications for the C-28. It is also well suited to general purpose trace recording.

8000-Series Microprocessor Labs Add 8085 Support

With complete 8085 software and hardware emulation, software development support, and hardware debug capability, the 8085 option for the TEKTRONIX 8000-Series Microprocessor Labs extends the coverage of this multiple-approach development aid to still another popular microprocessor. Previously announced options include support packages for the 8080, 6800, Z-80 and 9900.

Like the other 8000-Series microprocessor support packages, the 8085 option package runs as a component of the total Tektronix' systems approach to easing microprocessor based designs. The 8002 Microprocessor Lab, with dual floppy discs, up to 64k bytes of user memory, separate 16k system memory, and optional terminal provides

The 4014-1 Computer Display Terminal



an operating system and text editor to facilitate program development. Then, the program can be gradually integrated with a prototype by using the 8002 emulation and debug capabilities. The 8001 Microprocessor Lab — which is intended for users with time-sharing or other software development facilities — provides emulation and debug facilities, and uses a ROM-based operating system.

Intelligent Graphic Enhancement for the 4014

Users of the large screen 4014 Computer Display Terminal now have the opportunity to combine the graphic display superiority of the 4014 with proven techniques of distributed processing. All are designed to reduce data transmission and on-line time, speed up applications and interactivity, and further increase the ease of use, interactivity, and productivity of the 4014.

Three new options allow you to select the degree of enhancement to suit your particular needs:

Option 40 provides programmable keyboard capability with

storage of alphanumeric and graphics in local memory. Data may be entered from the keyboard or downloaded from the host or local peripheral devices. After loading, the data stored for any key may be displayed on the screen or transmitted to the host or local peripheral by simply depressing a key, or by the host transmitting the key value. The data stored under a key name could be an entire display, a graphic segment, a symbol, local commands, or the names of several other keys which also contain graphics.

For convenience a one line editor is included which maintains the most recent typed line in refresh. Graphic data may be displayed in the normal location or displayed in new locations by redefining the origin coordinates. In addition, Option 40 provides local clipping of any graphics outside the screen boundary and local buffering of all communications.

Option 41 adds local rotation and scaling (upwards and downwards) of graphics, use of any alternate downloaded character set, and local circle and circular arc generation. To assist in development of an alternate character set, a local symbol design mode is provided in which symbols or characters may be defined using the crosshair cursor or graphics tablet, then saved on a local peripheral or host.

Option 42 adds an interactive buffer to the 4014 providing 1023 bytes of off-screen storage which can be used as a straight buffer capable of storing or refreshing alphanumeric or graphic displays, as a text editor, or in conjunction with thumbwheels or an optional joystick to provide moveable picture elements. The picture elements may be positioned anywhere on-screen, rotated, or scaled locally or under program control.

A-3843

Tektronix, Inc.

P.O. Box 500
Beaverton, Oregon 97077

0421867 MAR 9 1978 1339
MR THOMAS P DOWNEY LAB TECH
GEOLOGY DEPT EPS-J106
CITY COLLEGE OF NEW YORK
138TH ST. & CONVENT AVE.
NEW YORK CITY NY 10031

BULK RATE
U.S. POSTAGE PAID
TEKTRONIX, INC.